



# PRODUCT CATALOG



## FASTER

Faster Start  
Faster Set  
Longer Battery Life



## STRONGER

Stronger Ceramic Coating  
Stronger Abrasion Resistance  
Treated Lumber Approved



## SAFER™

Safer Power Bit Fit  
Safer Hold  
Anti Slip Excellence

# Order Online

## Need current pricing? Working late? Want answers quickly?

With our easy-to-use web store, you can place orders, view pricing and much more!

Visit [www.k9fasteners.com](http://www.k9fasteners.com) and click **SHOP NOW** to get started!

- View your current pricing and real-time product inventory
- Access order status and tracking information
- See your order history
- View outstanding and available balances

Not a current Web store user? Signing up is easy.

Fill out the form at: [www.k9fasteners.com/account/register](http://www.k9fasteners.com/account/register)

If you are not a current K9 Fasteners customer, please contact us at 888.205.2355 or email us at [sales@k9fasteners.com](mailto:sales@k9fasteners.com)

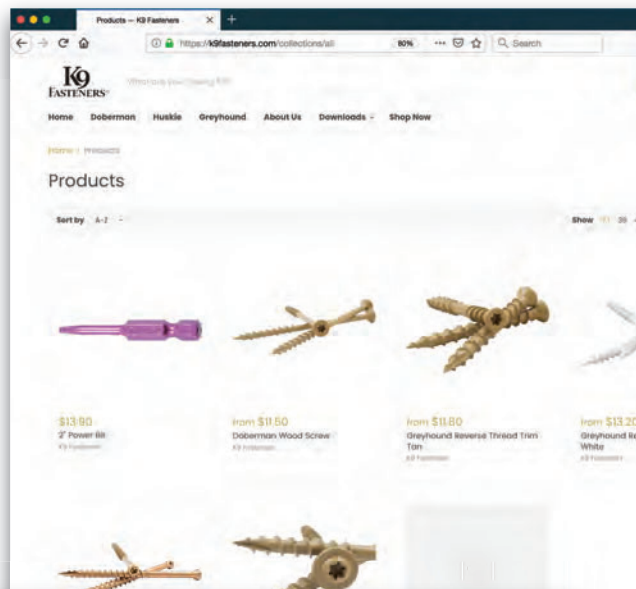

No More Secrets - FASTER - STRONGER - SAFER

**K9 FASTENERS** What are you looking for?   JOIN THE PACK!

Shop Now Doberman Huskie Greyhound About Us Tech Sheets Catalog Contact Us News Login

**FASTER - STRONGER - SAFER**

Click Here to Register to Win!  
Register to win free K9 product each and every month. Prizes valued at \$50.00 MSRP and no purchase is necessary. One entry per month is all it takes for a GOOD chance to WIN!

Meet the Pack

**Doberman**  
Our Doberman wood screw is the hardest working and loyal dog in the fight...

**Greyhound**  
Greyhound is the only line that gives you performance enhancements for various applications...



**Building the USA together as Partners and Friends**

Hello Friends,

The past 8 years has been packed with excitement as we continue sharing the exciting K9 Fasteners story all across the USA and internationally as well. HIGH gratitude is felt for all of our existing and new customers who share the truth of K9 excellence each and every day.

All of us at K9 love serving dealers and contractors alike in building America together as partners and friends. Comming Soon: LT-Long Thread Dobermans and Huskies! Stay tuned for more good news in the months ahead.

Blessings to you, your family and your team,

Barry Campbell

President



**Doberman™** Premium Deck Screw page 2 - 5



**Huskie™** Premium Construction Lag page 6 - 7



**Greyhound™** Premium Trim Screw page 8 - 9

**Performance Test** page 10 - 11

**Power Bits & Nut Setters™** page 12

**Order Form & Info** page 13 - 14

# Doberman™

## Premium Deck Screw

Hardest working and loyal dog in the fight.

- Quick-bite tip
- 3X ceramic protection
- Anti slip bit pocket
- T25 Power Bit included in every box



### TAN CERAMIC

K9 Item #	Screw Size	Color	Pack Size	Case Pack	Bit	MSRP*/Ea.	QTY/Pack	MSRP*
<b>D8132-158</b>	#9 x 1-5/8	Tan	1LB	20	T25	\$0.14	155	\$21.34
<b>D8132-200</b>	#9 x 2	Tan	1LB	20	T25	\$0.17	125	\$21.50
<b>D8132-212</b>	#9 x 2-1/2	Tan	1LB	20	T25	\$0.22	100	\$21.64
<b>D8132-300</b>	#9 x 3	Tan	1LB	20	T25	\$0.26	85	\$21.78
<b>D8132-312</b>	#10 x 3-1/2	Tan	1LB	20	T25	\$0.37	60	\$22.34
<b>D8132-318</b>	#10 x 3-1/8	Tan	1LB	4	T25	\$0.40	59	\$23.74
<b>D8133-114</b>	#9 x 1-1/4	Tan	5LB	4	T25	\$0.08	945	\$76.68
<b>D8133-158</b>	#9 x 1-5/8	Tan	5LB	4	T25	\$0.10	770	\$76.26
<b>D8133-200</b>	#9 x 2	Tan	5LB	4	T25	\$0.12	624	\$75.14

\*MSRP - Manufacturer's Suggested Retail Price is used to benchmark K9 Fasteners' value against competitive products.

For more information visit [www.k9fasteners.com](http://www.k9fasteners.com)

©2026-02 K9 Fasteners®

## TAN CERAMIC

K9 Item #	Screw Size	Color	Pack Size	Case Pack	Bit	MSRP*/Ea.	QTY/Pack	MSRP*
<b>D8133-212</b>	#9 x 2-1/2	Tan	5LB	4	T25	\$0.15	509	\$76.26
<b>D8133-300</b>	#9 x 3	Tan	5LB	4	T25	\$0.18	431	\$76.26
<b>D8133-318</b>	#10 x 3-1/8	Tan	5LB	4	T25	\$0.26	303	\$78.18
<b>D8133-312</b>	#10 x 3-1/2	Tan	5LB	4	T25	\$0.24	330	\$79.64
<b>D8133-400</b>	#10 x 4	Tan	5LB	4	T25	\$0.30	266	\$78.92
<b>D8133-500</b>	#10 x 5	Tan	5LB	4	T25	\$0.42	215	\$89.74
<b>D8133-600</b>	#12 x 6	Tan	5LB	4	T25	\$0.77	120	\$92.40
<b>D8133-700</b>	#12 x 7	Tan	5LB	4	T25	\$1.17	105	\$122.46
<b>D8133-800</b>	#12 x 8	Tan	5LB	4	T25	\$1.37	95	\$130.46
<b>D8133-1000</b>	#12 x 10	Tan	5LB	4	T25	\$2.13	75	\$159.54
<b>D8133-1200</b>	#12 x 12	Tan	5LB	4	T25	\$2.76	65	\$179.34
<b>D8134-114</b>	#9 x 1-1/4	Tan	1/4 Keg	1	T25	\$0.06	5000	\$316.24
<b>D8134-158</b>	#9 x 1-5/8	Tan	1/4 Keg	1	T25	\$0.08	4500	\$338.84

\*MSRP - Manufacturer's Suggested Retail Price is used to benchmark K9 Fasteners' value against competitive products.

## TAN CERAMIC

K9 Item #	Screw Size	Color	Pack Size	Case Pack	Bit	MSRP*/Ea.	QTY/Pack	MSRP*
<b>D8134-200</b>	#9 x 2	Tan	1/4 Keg	1	T25	\$0.10	3500	\$360.34
<b>D8134-212</b>	#9 x 2-1/2	Tan	1/4 Keg	1	T25	\$0.13	2500	\$319.48
<b>D8134-300</b>	#9 x 3	Tan	1/4 Keg	1	T25	\$0.15	2000	\$305.58
<b>D8134-318</b>	#10 x 3-1/8	Tan	1/4 Keg	1	T25	\$0.21	1600	\$330.84
<b>D8134-312</b>	#10 x 3-1/2	Tan	1/4 Keg	1	T25	\$0.23	1500	\$339.42
<b>D8134-400</b>	#10 x 4	Tan	1/4 Keg	1	T25	\$0.27	1000	\$268.92
<b>D8134-500</b>	#10 x 5	Tan	1/4 Keg	1	T25	\$0.38	850	\$325.08
<b>D8134-600</b>	#12 x 6	Tan	1/4 Keg	1	T25	\$0.67	500	\$336.60
<b>D8134-700</b>	#12 x 7	Tan	1/4 Keg	1	T25	\$1.07	400	\$426.60
<b>D8134-800</b>	#12 x 8	Tan	1/4 Keg	1	T25	\$1.27	300	\$380.40
<b>D8134-1000</b>	#12 x 10	Tan	1/4 Keg	1	T25	\$1.84	300	\$551.30
<b>D8134-1200</b>	#12 x 12	Tan	1/4 Keg	1	T25	\$2.38	300	\$714.88

\*MSRP - Manufacturer's Suggested Retail Price is used to benchmark K9 Fasteners' value against competitive products.



**FASTER STRONGER SAFER®**

All of us here at K9 are thrilled to have this opportunity to continue the legacy of loyalty, value and performance that thousands of professionals have come to depend on. We lead with over 15 years of diligence and continuous improvement for our customers and within our line of K9 Fastener products.

**FASTENER FACTS:**

**FASTER** - Our Quick Bite Tip™ starts faster and our optimized thread design sets faster than any of our competitors.

**STRONGER** - Independent laboratory data, printed engineering data and contractor testimonies prove unsurpassed coating and steel strength.

**SAFER** - Our Anti Slip Power Pocket provides one-handed fastener installation and the cure for bloody knuckles and damaged work surfaces.

**VALUE** - Value is a powerful formula for success and value pricing provides the strongest profitability for your business with K9 Products. Let us show you how to effectively merchandise our products to build the K9 brand and build your profitability with NO COMPETITION FROM BIG BOX STORES!

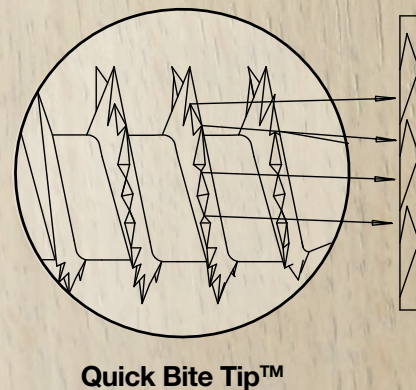
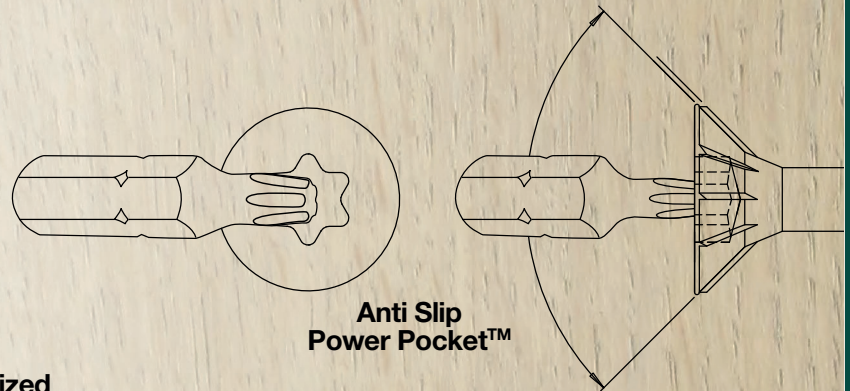
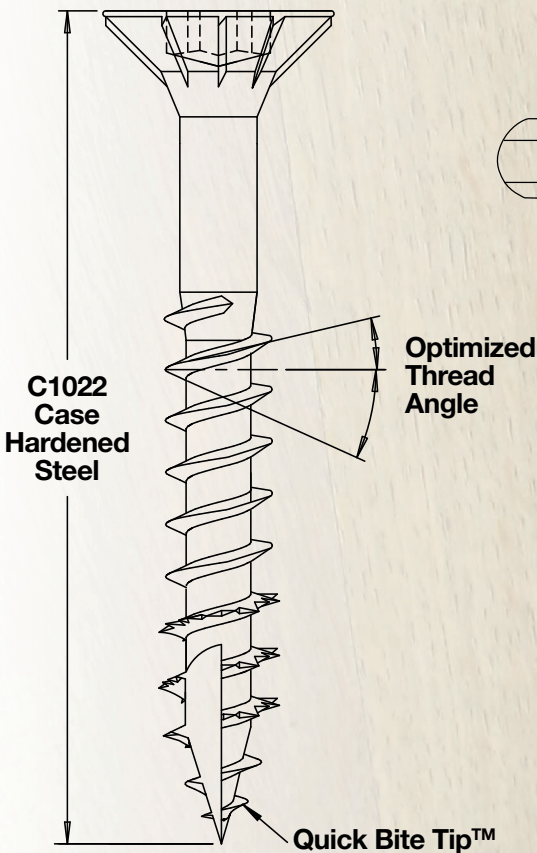
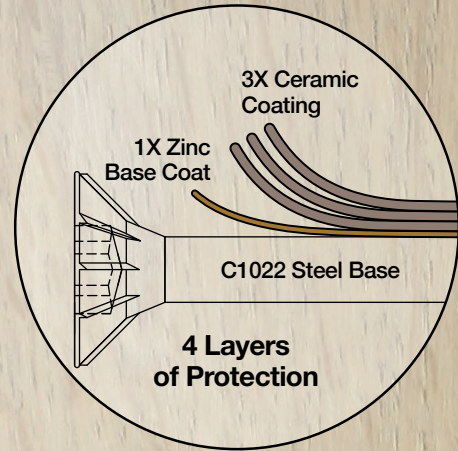

# Huskie™

## Premium Construction Lag

Pulls more weight, holds more weight, and starts with ease.

- Quick-bite tip
- 3X ceramic protection
- Anti slip bit pocket
- T30 or T40 Power Bit included in every box

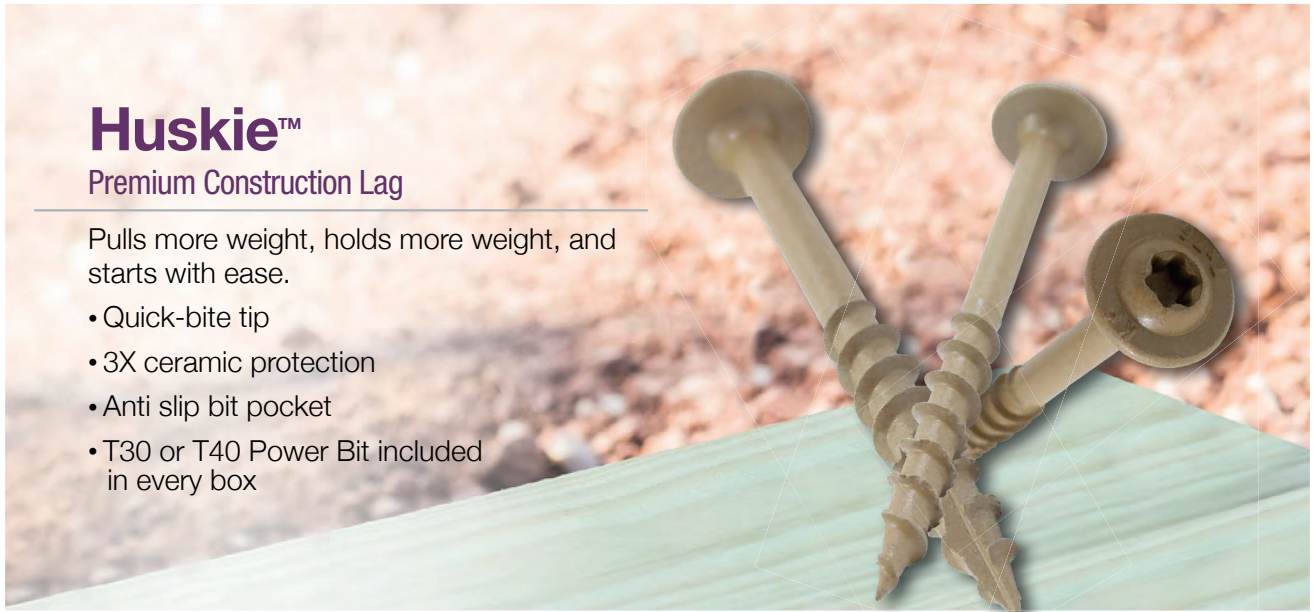

### TAN CERAMIC

K9 Item #	Screw Size	Color	Pack Size	Case Pack	Bit	MSRP*/Ea.	QTY/Pack	MSRP*
<b>H8233-114</b>	5/16 x 1-1/4	Tan	5LB	4	T40	\$0.28	300	\$83.56
<b>H8233-212</b>	5/16 x 2-1/2	Tan	5LB	4	T40	\$0.45	175	\$78.78
<b>H8233-300</b>	5/16 x 3	Tan	5LB	4	T40	\$0.53	150	\$78.92
<b>H8233-312</b>	5/16 x 3-1/2	Tan	5LB	4	T40	\$0.57	140	\$79.22
<b>H8233-400</b>	5/16 x 4	Tan	5LB	4	T40	\$0.63	125	\$79.36
<b>H8233-500</b>	5/16 x 5	Tan	5LB	4	T40	\$0.89	100	\$88.62
<b>H8233-600</b>	5/16 x 6	Tan	5LB	4	T40	\$1.08	90	\$97.04
<b>H8233-800</b>	3/8 x 8	Tan	5LB	4	T40	\$2.47	55	\$135.94
<b>H8233-1000</b>	3/8 x 10	Tan	5LB	1	T40	\$3.95	45	\$177.94

\*MSRP - Manufacturer's Suggested Retail Price is used to benchmark K9 Fasteners' value against competitive products.

**TAN CERAMIC**

K9 Item #	Screw Size	Color	Pack Size	Case Pack	Bit	MSRP*/Ea.	QTY/Pack	MSRP*
<b>H8233-1200</b>	3/8 x 12	Tan	5LB	4	T40	\$5.17	38	\$196.60
<b>H8234-212</b>	5/16 x 3	Tan	1/4 Keg	1	T30	\$0.35	830	\$286.74
<b>H8234-300</b>	5/16 x 3	Tan	1/4 Keg	1	T30	\$0.45	600	\$267.24
<b>H8234-312</b>	5/16 x 3-1/2	Tan	1/4 Keg	1	T30	\$0.53	500	\$262.88
<b>H8234-400</b>	5/16 x 4	Tan	1/4 Keg	1	T30	\$0.58	400	\$233.54
<b>H8234-500</b>	5/16 x 5	Tan	1/4 Keg	1	T30	\$0.80	350	\$280.16
<b>H8234-600</b>	5/16 x 6	Tan	1/4 Keg	1	T30	\$1.06	300	\$318.48
<b>H8234-800</b>	3/8 x 8	Tan	1/4 Keg	1	T40	\$2.36	200	\$472.54
<b>H8234-1000</b>	3/8 x 10	Tan	1/4 Keg	1	T40	\$2.97	180	\$535.28
<b>H8234-1200</b>	3/8 x 12	Tan	1/4 Keg	1	T40	\$3.75	150	\$561.82

**K9 Fastener® Facts**

**STRONGER-** Our Huskie ASTM tests reveal over 3,400 lbs. of pull through force and over 4,700 lbs. of shank shear test force on respective sizes. (Complete test data on page 11 of the catalog)

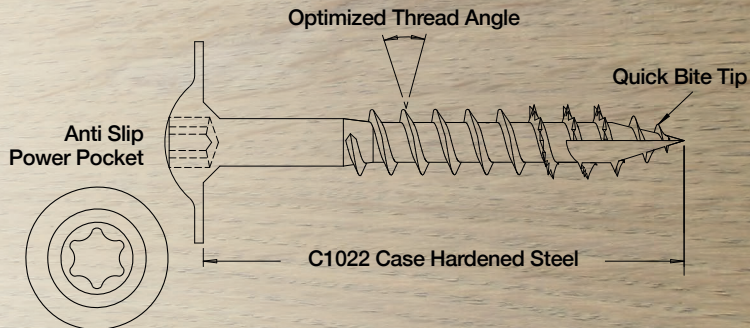

\*MSRP - Manufacturer's Suggested Retail Price is used to benchmark K9 Fasteners' value against competitive products.

# Greyhound™

## Premium Reverse Thread Trim Screw

Innovation in head design provides application options and stronger holding power.

- Quick-bite tip
- 3X ceramic protection
- Anti slip bit pocket
- Interior and exterior options
- T10 Power Bit included in every box



### TAN CERAMIC - Ideal for exterior trim and railing

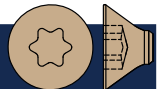

K9 Item #	Screw Size	Color	Pack Size	Case Pack	Bit	MSRP*/Ea.	QTY/Pack	MSRP*
<b>G8031-158</b>	#8 x 1-5/8	Tan	100 ct	20	T10	\$0.16	100	\$16.46
<b>G8031-200</b>	#8 x 2	Tan	100 ct	20	T10	\$0.17	100	\$17.42
<b>G8031-212</b>	#8 x 2-1/2	Tan	100 ct	20	T10	\$0.20	100	\$19.52
<b>G8031-300</b>	#8 x 3	Tan	100 ct	20	T10	\$0.23	100	\$23.18
<b>G8033-158</b>	#8 x 1-5/8	Tan	5LB	20	T10	\$0.08	1000	\$82.58
<b>G8033-200</b>	#8 x 2	Tan	5LB	20	T10	\$0.10	850	\$84.40
<b>G8033-212</b>	#8 x 2-1/2	Tan	5LB	20	T10	\$0.13	665	\$86.24
<b>G8033-300</b>	#8 x 3	Tan	5LB	20	T10	\$0.17	530	\$88.32

\*MSRP - Manufacturer's Suggested Retail Price is used to benchmark K9 Fasteners' value against competitive products.

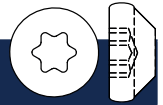

**WHITE CERAMIC - Exterior use and composite applications**

K9 Item #	Screw Size	Color	Pack Size	Case Pack	Bit	MSRP*/Ea.	QTY/Pack	MSRP*
<b>G8021-158</b>	#8 x 1-5/8	White	100 ct	4	T10	\$0.16	100	\$16.46
<b>G8021-200</b>	#8 x 2	White	100 ct	4	T10	\$0.18	100	\$17.56
<b>G8021-212</b>	#8 x 2-1/2	White	100 ct	4	T10	\$0.20	100	\$19.52
<b>G8021-300</b>	#8 x 3	White	100 ct	4	T10	\$0.22	100	\$21.64

**K9 Fastener® Facts**

With many trim screws to choose from on the market consider the fact that Greyhound is the only line that gives you performance enhancements for various applications.

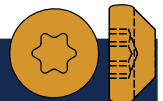
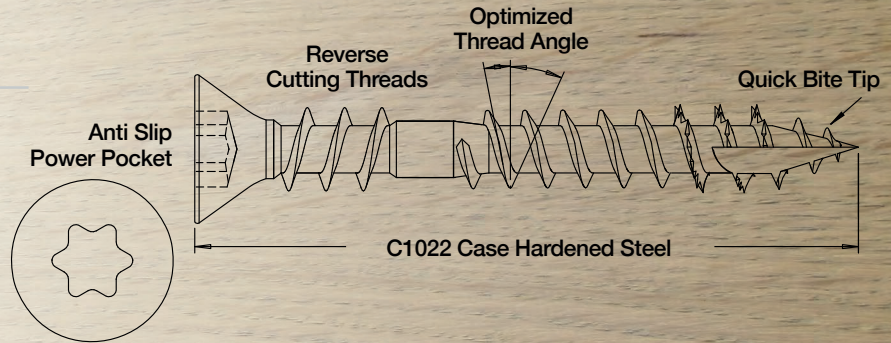

**YELLOW ZINC - Interior use only**

K9 Item #	Screw Size	Color	Pack Size	Case Pack	Bit	MSRP*/Ea.	QTY/Pack	MSRP*
<b>G8011-158</b>	#8 x 1-5/8	Yellow Zinc	100 ct	20	T10	\$0.08	1000	\$82.58
<b>G8011-200</b>	#8 x 2	Yellow Zinc	100 ct	20	T10	\$0.10	850	\$84.40
<b>G8011-212</b>	#8 x 2-1/2	Yellow Zinc	100 ct	20	T10	\$0.13	665	\$86.24
<b>G8011-300</b>	#8 x 3	Yellow Zinc	100 ct	20	T10	\$0.17	530	\$88.32

\*MSRP - Manufacturer's Suggested Retail Price is used to benchmark K9 Fasteners' value against competitive products.  
 \*\*Yellow Zinc - Interior use only. Not intended for exterior use.

# Doberman™

## Screw Performance Test

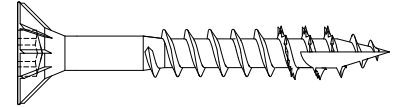
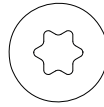

### Material

- C1022 steel, yellow zinc plated
- Triple ceramic coated
- Certified for ACQ and all treated lumber

### Package Sizes

- 1 lb. Box
- 5 lb. Box
- 1/4 Keg (approximate weight: 20-25 lbs.)

**Pull Out Test** – Performed per ASTM-D-1761 Standard. Measures the maximum force (in pounds) required to pull the fastener out of the wood while all of the threads are in the wood.

**Pull Through Test** – Performed per ETL 526848 Standard. Measures the maximum force (in pounds) required to pull the head of the fastener through the wood.

**Shank Shear Test** – Performed per ASTM –F - 606 Standard. Measures the force (in pounds) required to shear the shank of the fastener.

*Passes a 2,880 (90-day) salt spray test, exceeding the AC257 treated lumber requirements by 50%.*

*All tests were performed by an independent and accredited laboratory.*

Screw Size	PULL OUT TEST ASTM-D-1761 Standard Average Max. Force	PULL THROUGH TEST ETL 526848 Standard Average Max. Force	SHANK SHEAR TEST ASTM –F - 606 Standard Average Force to Shear Shank
#9 x 1 ¼"	272 lbs.	373 lbs.	1,214 lbs.
#9 x 1 5/8"	475 lbs.	516 lbs.	1,185 lbs.
#9 x 2"	452 lbs.	449 lbs.	1,482 lbs.
#9 x 2 ½"	672 lbs.	533 lbs.	1,125 lbs.
#9 x 3"	811 lbs.	327 lbs.	1,138 lbs.
#10 x 3 ½"	796 lbs.	577 lbs.	1,971 lbs.
#10 x 4"	1,254 lbs.	332 lbs.	1,566 lbs.
#10 x 5"	1,469 lbs.	324 lbs.	1,632 lbs.
#12 x 6"	1,604 lbs.	630 lbs.	2,684 lbs.
#12 x 7"	1,389 lbs.	477 lbs.	2,327 lbs.
#12 x 8"	1,957 lbs.	530 lbs.	2,196 lbs.
#12 x 10"	1,778 lbs.	857 lbs.	2,698 lbs.
#12 x 12"	1,617 lbs.	661 lbs.	2,684 lbs.

# Huskie™

## Screw Performance Test

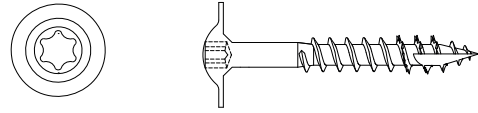

### Material

- C1022 steel, yellow zinc plated
- Triple ceramic coated
- Certified for ACQ and all treated lumber

### Package Sizes

- 5 lb. Box
- 1/4 Keg (approximate weight: 20-25 lbs.)

**Pull Out Test** – Performed per ASTM-D-1761 Standard. Measures the maximum force (in pounds) required to pull the fastener out of the wood while all of the threads are in the wood.

**Pull Through Test** – Performed per ETL 526848 Standard. Measures the maximum force (in pounds) required to pull the head of the fastener through the wood.

**Shank Shear Test** – Performed per ASTM –F - 606 Standard. Measures the force (in pounds) required to shear the shank of the fastener.

*Passes a 2,880 (90-day) salt spray test, exceeding the AC257 salt spray requirements by 50%.*

*All tests were performed by an independent and accredited laboratory.*

Screw Size	PULL OUT TEST ASTM-D-1761 Standard Average Max. Force	PULL THROUGH TEST ETL 526848 Standard Average Max. Force	SHANK SHEAR TEST ASTM –F - 606 Standard Average Force to Shear Shank
5/16" x 3 1/2"	1,349 lbs.	1,290 lbs.	3,569 lbs.
5/16" x 4"	1,437 lbs.	1,172 lbs.	2,742 lbs.
5/16" x 5"	1,647 lbs.	1,796 lbs.	3,338 lbs.
5/16" x 6"	1,714 lbs.	2,805 lbs.	4,496 lbs.
3/8" x 8"	1,637 lbs.	3,473 lbs.	4,786 lbs.
3/8" x 10"	1,627 lbs.	3,006 lbs.	4,411 lbs.
3/8" x 12"	1,748 lbs.	2,733 lbs.	3,617 lbs.



# Power Bits™ & Nut Setters

## Reverse Thread Trim Screw

Power Bits™ and Nut Setters provide the safest anti slip performance and unparalleled confidence

- 1" Power Bit™ insert included in every package
- Bright colors for fast identification
- K9 Power Bit™ pocket optimized specifically for use with K9 Power Bits
- FASTER - Color & size identification
- STRONGER - Bit fit & magnet strength
- SAFER - One handed install



### 1" Power Bit™ Insert

K9 Item #	Description	Case Pack	MSRP*/Ea.	MSRP*
PB2011-10	10 Purple	10	\$1.40	\$14.40
PB2011-15	15 Blue	10	\$1.40	\$14.40
PB2011-20	20 Green	10	\$1.40	\$14.40
PB2011-25	25 Yellow	10	\$1.40	\$14.40
PB2011-30	30 Orange	10	\$1.40	\$14.40
PB2011-40	40 Red	10	\$1.40	\$14.40

### 2" Star Head Power™ Bits

K9 Item #	Description	Pack Qty	Case Qty	MSRP*/Ea.	MSRP*
PB2021-10	10 Purple	10	10	\$2.59	\$25.86
PB2021-15	15 Blue	10	10	\$2.59	\$25.86
PB2021-20	20 Green	10	10	\$2.59	\$25.86
PB2021-25	25 Yellow	10	10	\$2.59	\$25.86
PB2021-30	30 Orange	10	10	\$2.59	\$25.86
PB2021-40	40 Red	10	10	\$2.59	\$25.86

### Magnetic Nut Setters

K9 Item #	Description	Pack Qty	Case Qty	MSRP*/Ea.	MSRP*
NS3001-14	1/4" Blue	10	10	\$7.12	\$71.22
NS3001-516	5/16" Yellow	10	10	\$7.98	\$79.76
NS3001-38	3/8" Orange	10	10	\$8.58	\$85.80
NS3001-716	7/16" Red	10	10	\$10.57	\$105.74

\*MSRP - Manufacturer's Suggested Retail Price is used to benchmark K9 Fasteners' value against competitive products.

# K9 Fasteners Order Form

Company Name: \_\_\_\_\_  
 Shipping Address: \_\_\_\_\_  
 Company Phone: \_\_\_\_\_ Fax: \_\_\_\_\_  
 Email Address: \_\_\_\_\_ PO Number: \_\_\_\_\_  
 Order Date: \_\_\_\_\_ Total Pages Of Order: \_\_\_\_\_

Qty.	K9 Item #	Screw Size	Color	Pack Size	MSRP*/Ea.	QTY	MSRP*
	D8132-158	#9 x 1-5/8	Tan	1LB	\$0.14	155	\$21.34
	D8132-200	#9 x 2	Tan	1LB	\$0.17	125	\$21.50
	D8132-212	#9 x 2-1/2	Tan	1LB	\$0.22	100	\$21.64
	D8132-300	#9 x 3	Tan	1LB	\$0.26	85	\$21.78
	D8132-312	#10 x 3-1/2	Tan	1LB	\$0.37	60	\$22.34
	D8132-318	#10 x 3-1/8	Tan	1LB	\$0.40	59	\$23.74
	D8133-114	#9 x 1-1/4	Tan	5LB	\$0.08	945	\$76.68
	D8133-158	#9 x 1-5/8	Tan	5LB	\$0.10	770	\$76.26
	D8133-200	#9 x 2	Tan	5LB	\$0.12	624	\$75.14
	D8133-212	#9 x 2-1/2	Tan	5LB	\$0.15	509	\$76.26
	D8133-300	#9 x 3	Tan	5LB	\$0.18	431	\$76.26
	D8133-318	#10 x 3-1/8	Tan	5LB	\$0.26	303	\$78.78
	D8133-312	#10 x 3-1/2	Tan	5LB	\$0.24	330	\$79.64
	D8133-400	#10 x 4	Tan	5LB	\$0.30	266	\$78.92
	D8133-500	#10 x 5	Tan	5LB	\$0.42	215	\$89.74
	D8133-600	#12 x 6	Tan	5LB	\$0.77	120	\$92.40
	D8133-700	#12 x 7	Tan	5LB	\$1.17	105	\$122.46
	D8133-800	#12 x 8	Tan	5LB	\$1.37	95	\$130.46
	D8133-1000	#12 x 10	Tan	5LB	\$2.13	75	\$159.54
	D8133-1200	#12 x 12	Tan	5LB	\$2.76	65	\$179.34
	D8134-114	#9 x 1-1/4	Tan	1/4 Keg	\$0.06	5000	\$316.24
	D8134-158	#9 x 1-5/8	Tan	1/4 Keg	\$0.08	4500	\$338.84
	D8134-200	#9 x 2	Tan	1/4 Keg	\$0.10	3500	\$360.34
	D8134-212	#9 x 2-1/2	Tan	1/4 Keg	\$0.13	2500	\$319.48
	D8134-300	#9 x 3	Tan	1/4 Keg	\$0.15	2000	\$305.58
	D8134-318	#10 x 3-1/8	Tan	1/4 Keg	\$0.21	1600	\$330.84
	D8134-312	#10 x 3-1/2	Tan	1/4 Keg	\$0.23	1500	\$339.42
	D8134-400	#10 x 4	Tan	1/4 Keg	\$0.27	1000	\$268.92
	D8134-500	#10 x 5	Tan	1/4 Keg	\$0.38	850	\$325.08
	D8134-600	#12 x 6	Tan	1/4 Keg	\$0.67	500	\$336.60
	D8134-700	#12 x 7	Tan	1/4 Keg	\$1.07	400	\$426.60
	D8134-800	#12 x 8	Tan	1/4 Keg	\$1.27	300	\$380.40
	D8134-1000	#12 x 10	Tan	1/4 Keg	\$1.84	300	\$551.30
	D8134-1200	#12 x 12	Tan	1/4 Keg	\$2.38	300	\$714.88

\*MSRP - Manufacturer's Suggested Retail Price is used to benchmark K9 Fasteners' value against competitive products. For more products, continue on next page

Company Name: \_\_\_\_\_ Company Phone: \_\_\_\_\_ Fax: \_\_\_\_\_  
 Shipping Address: \_\_\_\_\_ PO Number: \_\_\_\_\_ Order Date: \_\_\_\_\_  
 Email Address: \_\_\_\_\_  
 Total Pages Of Order: \_\_\_\_\_

Qty.	K9 Item #	Screw/Bit Size	Color	Pack Size	MSRP*/Ea.	QTY	MSRP
	<b>H8233-114</b>	<b>5/16 x 1-1/4</b>	Tan	5LB	\$0.28	300	\$83.56
	<b>H8233-212</b>	<b>5/16 x 2-1/2</b>	Tan	5LB	\$0.45	175	\$78.78
	<b>H8233-300</b>	<b>5/16 x 3</b>	Tan	5LB	\$0.53	150	\$78.92
	<b>H8233-312</b>	<b>5/16 x 3-1/2</b>	Tan	5LB	\$0.57	140	\$79.22
	<b>H8233-400</b>	<b>5/16 x 4</b>	Tan	5LB	\$0.63	125	\$79.36
	<b>H8233-500</b>	<b>5/16 x 5</b>	Tan	5LB	\$0.89	100	\$88.62
	<b>H8233-600</b>	<b>5/16 x 6</b>	Tan	5LB	\$1.08	90	\$97.04
	<b>H8233-800</b>	<b>3/8 x 8</b>	Tan	5LB	\$2.47	55	\$135.94
	<b>H8233-1000</b>	<b>3/8 x 10</b>	Tan	5LB	\$3.95	45	\$177.94
	<b>H8233-1200</b>	<b>3/8 x 12</b>	Tan	5LB	\$5.17	38	\$196.60
	<b>H8234-212</b>	<b>5/16 x 2-1/2</b>	Tan	1/4 Keg	\$0.35	830	\$286.74
	<b>H8234-300</b>	<b>5/16 x 3</b>	Tan	1/4 Keg	\$0.45	600	\$267.24
	<b>H8234-312</b>	<b>5/16 x 3-1/2</b>	Tan	1/4 Keg	\$0.53	500	\$262.88
	<b>H8234-400</b>	<b>5/16 x 4</b>	Tan	1/4 Keg	\$0.58	400	\$233.54
	<b>H8234-500</b>	<b>5/16 x 5</b>	Tan	1/4 Keg	\$0.80	350	\$280.16
	<b>H8234-600</b>	<b>5/16 x 6</b>	Tan	1/4 Keg	\$1.06	300	\$318.48
	<b>H8234-800</b>	<b>3/8 x 8</b>	Tan	1/4 Keg	\$2.36	200	\$472.54
	<b>H8234-1000</b>	<b>3/8 x 10</b>	Tan	1/4 Keg	\$2.97	180	\$535.28
	<b>H8234-1200</b>	<b>3/8 x 12</b>	Tan	1/4 Keg	\$3.75	150	\$561.82
	<b>G8011-158</b>	<b>#8 x 1-5/8</b>	Yellow Zinc	100 ct	\$0.14	100	\$13.90
	<b>G8011-200</b>	<b>#8 x 2</b>	Yellow Zinc	100 ct	\$0.16	100	\$15.88
	<b>G8011-212</b>	<b>#8 x 2-1/2</b>	Yellow Zinc	100 ct	\$0.19	100	\$19.12
	<b>G8011-300</b>	<b>#8 x 3</b>	Yellow Zinc	100 ct	\$0.21	100	\$21.34
	<b>G8021-158</b>	<b>#8 x 1-5/8</b>	White	100 ct	\$0.16	100	\$16.46
	<b>G8021-200</b>	<b>#8 x 2</b>	White	100 ct	\$0.18	100	\$17.56
	<b>G8021-212</b>	<b>#8 x 2-1/2</b>	White	100 ct	\$0.20	100	\$19.52
	<b>G8021-300</b>	<b>#8 x 3</b>	White	100 ct	\$0.22	100	\$21.64
	<b>G8031-158</b>	<b>#8 x 1-5/8</b>	Tan	100 ct	\$0.16	100	\$16.46
	<b>G8031-200</b>	<b>#8 x 2</b>	Tan	100 ct	\$0.17	100	\$17.42
	<b>G8031-212</b>	<b>#8 x 2-1/2</b>	Tan	100 ct	\$0.20	100	\$19.52
	<b>G8031-300</b>	<b>#8 x 3</b>	Tan	100 ct	\$0.23	100	\$23.18
	<b>G8033-158</b>	<b>#8 x 1-5/8</b>	Tan	5LB	\$0.08	1000	\$82.58
	<b>G8033-200</b>	<b>#8 x 2</b>	Tan	5LB	\$0.10	850	\$84.40
	<b>G8033-212</b>	<b>#8 x 2-1/2</b>	Tan	5LB	\$0.13	665	\$86.24
	<b>G8033-300</b>	<b>#8 x 3</b>	Tan	5LB	\$0.17	530	\$88.32
	<b>PB2011-10</b>	<b>T10 1" Power Bit</b>	Purple	10/pack	\$1.40	10	\$14.04
	<b>PB2011-15</b>	<b>T15 1" Power Bit</b>	Blue	10/pack	\$1.40	10	\$14.04
	<b>PB2011-20</b>	<b>T20 1" Power Bit</b>	Green	10/pack	\$1.40	10	\$14.04
	<b>PB2011-25</b>	<b>T25 1" Power Bit</b>	Yellow	10/pack	\$1.40	10	\$14.04
	<b>PB2011-30</b>	<b>T30 1" Power Bit</b>	Orange	10/pack	\$1.40	10	\$14.04
	<b>PB2011-40</b>	<b>T40 1" Power Bit</b>	Red	10/pack	\$1.40	10	\$14.04
	<b>PB2021-10</b>	<b>T10 2" Power Bit</b>	Purple	10/pack	\$2.59	10	\$25.86
	<b>PB2021-15</b>	<b>T15 2" Power Bit</b>	Blue	10/pack	\$2.59	10	\$25.86
	<b>PB2021-20</b>	<b>T20 2" Power Bit</b>	Green	10/pack	\$2.59	10	\$25.86
	<b>PB2021-25</b>	<b>T25 2" Power Bit</b>	Yellow	10/pack	\$2.59	10	\$25.86
	<b>PB2021-30</b>	<b>T30 2" Power Bit</b>	Orange	10/pack	\$2.59	10	\$25.86
	<b>PB2021-40</b>	<b>T40 2" Power Bit</b>	Red	10/pack	\$2.59	10	\$25.86
	<b>NS3001-14</b>	<b>1/4"</b>	Blue	10/pack	\$7.12	10	\$71.22
	<b>NS3001-516</b>	<b>5/16"</b>	Yellow	10/pack	\$7.98	10	\$79.76
	<b>NS3001-38</b>	<b>3/8"</b>	Orange	10/pack	\$8.58	10	\$85.80
	<b>NS3001-716</b>	<b>7/16"</b>	Red	10/pack	\$10.57	10	\$105.74

**HUSKIE™ LAG SCREW**

**GREYHOUND™ TRIM SCREW**

**POWER BIT**

**MAGNETIC NUT SETTER**



### **ORDERING FROM K9 Fasteners**

- Prices are subject to change without notice. For up-to-date pricing, visit [www.k9fasteners.com](http://www.k9fasteners.com).
- To ensure 100% accuracy orders are preferred via fax, e-mail, or online at [www.k9fasteners.com](http://www.k9fasteners.com).
- Shipping charges appear on your sales order confirmation.

### **ORDERING TERMS**

- Approved credit application, sales tax #, W9 and references are required to establish a new account.
- Invoice terms are NET 30 days, aged from invoice date. Past-due accounts are charged 1.5% per month on past-due amounts. Orders from past-due accounts are put on hold.

### **SHIPPING TERMS**

- Shipments are prepaid at \$1,500 NET for orders shipped within the continental United States.
- Delivery charges for orders shipped to Alaska and Hawaii will be quoted prior to shipment.
- K9 Fasteners will select the carrier for all shipments.
- A \$50 drop-ship fee will be added to all orders shipped directly to a residence or a retailers customer.

### **PICKUPS**

- We do not have counter service

### **RETURNS/CREDITS/SHIPPING ERRORS**

- A Return Merchandise Authorization (RMA) is required for all returns.
- Customers have 30 days to request a RMA from our customer service department.
- Product must be returned within 10 days after receipt of the RMA.
- Returns for any reason other than manufacturer defect or K9 Fasteners error are subject to a 15% restocking fee.
- In all instances, the product must be returned in saleable condition, in the original packaging and inside an outer carton. Any return with price stickers, label damage or other package damage will be rejected.
- All claims for shortage and/or damaged goods must be reported within five days from receipt of merchandise.

## **Business Hours 8:00 AM to 5:00 PM Central Time**

### **PLEASE BE ADVISED**

- Possession of this catalog does not constitute permission to purchase or an obligation to sell.
- Product prices are subject to change without notice.
- Prepaid shipping minimum subject to change.



## HAPPY ANNIVERSARY

2025 marked 16 years of success for K9 fasteners®. We have hundreds of retailers and thousands of builders that choose the loyalty, value and performance of our fasteners every single day. Experience for yourself how Doberman™, Huskie™ and Greyhound™ products are Faster Stronger Safer®

### Hours & Location:

8:00 AM to 5:00 PM Central Time

PO Box 2673  
Appleton, WI 54912

Tel: 888.205.2355

Fax: 888.839.5997

Email: [sales@k9fasteners.com](mailto:sales@k9fasteners.com)

**VISIT US AT:**  
[www.k9fasteners.com](http://www.k9fasteners.com)

©2026-02 K9 Fasteners®

***“K9 Fasteners have really caught on over the past 6 years. Our customers love them because they are the best value compared to the over-priced competition.”***

***- R.C. Goodwyn & Sons  
Powhatan, VA***

***“There are many reasons to choose K9 Fasteners but the fast starts, ceramic coating and product strength have made both Doberman deck screws and Huskie lags a winner for us for many years.”***

***- Beaver Builders Supply Inc.  
Holmen, WI***

***“I have NEVER-EVER had a performance problem in the 9 years I have sold K9. This product is a GREAT value for me and my customers.”***

***- Hennen Lumber Company  
Freeport, MN***

***“K9 fasteners are the real deal. They don’t snap off like other brands when put to the true test in the field, they’re faster, and less expensive than the competition”***

***- Ethan Coop Lumber  
Ethan, SD***

***“Good quality product at the best price. We have not found anything better than K9 anywhere else.”***

***- Pioneer General Store  
Mio MI***

**JOIN THE PACK!®**